

Wideband Transformer

EBH5553-B034026

2019-11-12 Rev. 0

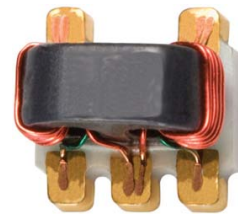

1:4 50Ω:200Ω 5-1250 MHz

Outline Drawing(mm)

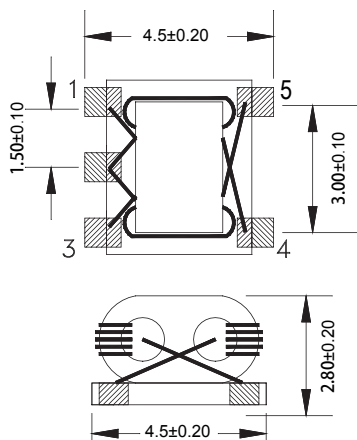

Electrical structure

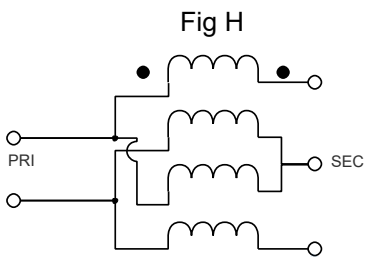

Recommended layout(mm)

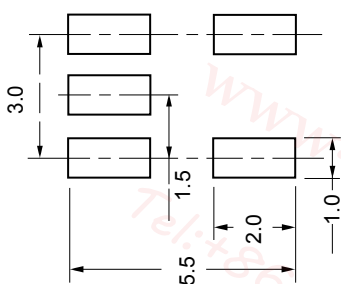

Pin Connections

Pin no.	Function
1	Secondary Dot
2	Secondary Centre Tap
3	Secondary
4	Primary
5	Primary Dot

Features

- Excellent Temperature Stability
- RoHS Compliant and Pb Free
- 260°C Reflow Compatible
- Power Input(as a splitter): 0.5W Max
- DC current: 50mA
- Operating temperature range: -40 C to +125 C
- Storage temperature range: -55 C to +100 C

Applications

- RF circuits
- Mobile radio
- Satellite TV
- Cordless phones

Electrical Specifications:TA=25°C, 0dBm, Z0=50Ω

Application circuit

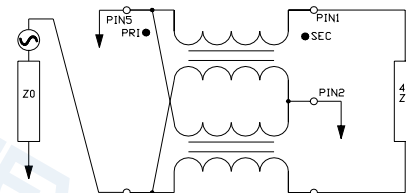

Parameter	Test Conditions	Units	Min	Typ	Max
Insertion Loss 1(Pin4-3)	5-1250MHz	dB	—	1.4	2.0
Insertion Loss 1(Pin4-1)	5-1250MHz	dB	—	1.6	2.0
Amplitude Balance	5-1250MHz	dB	0.0	0.2	1.0
Phase Balance	5-1250MHz	°	0.0	8.0	20.0
Return Loss(Pin4)	5-1250MHz	dB	6.0	20.0	—

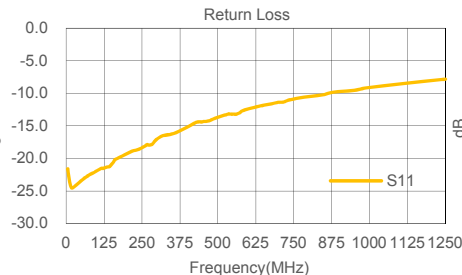
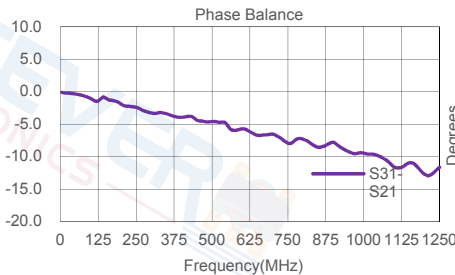
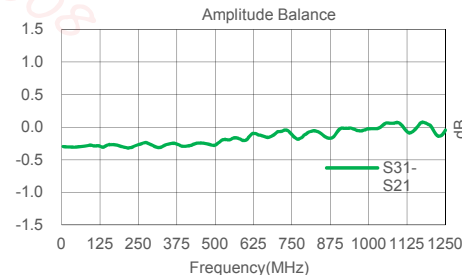
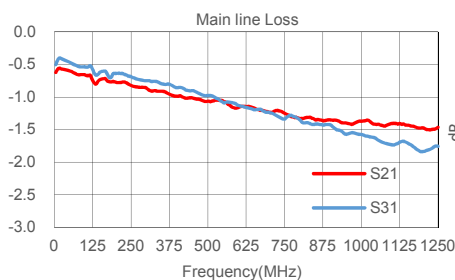

Carrier Tape Orientation

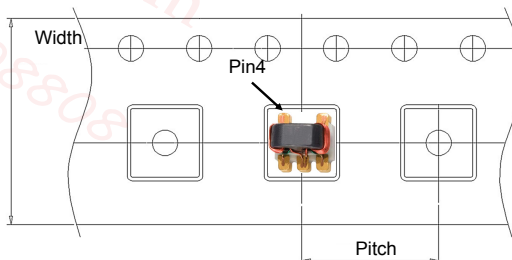

Tape & Reel Information

Parameter	Units	Value
Qty per reel	PCS	2000
Reel Size	mm	330
Tape Width	mm	12.00
Pitch	mm	8.00
Ao	mm	4.70
Bo	mm	4.70
Ko	mm	2.90