

LAN Transformer

10/100 BASE-TX P16511G

REV: 0

A. MECHANICAL(unit:mm)

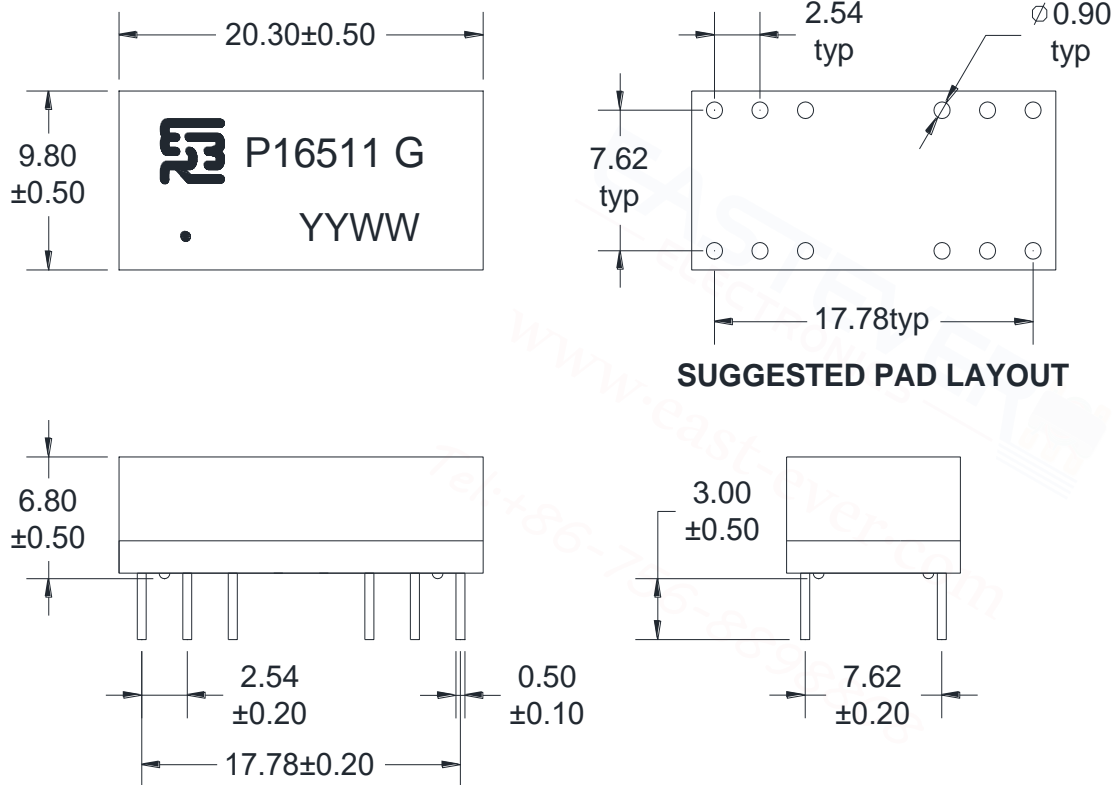

B. SCHEMATICS

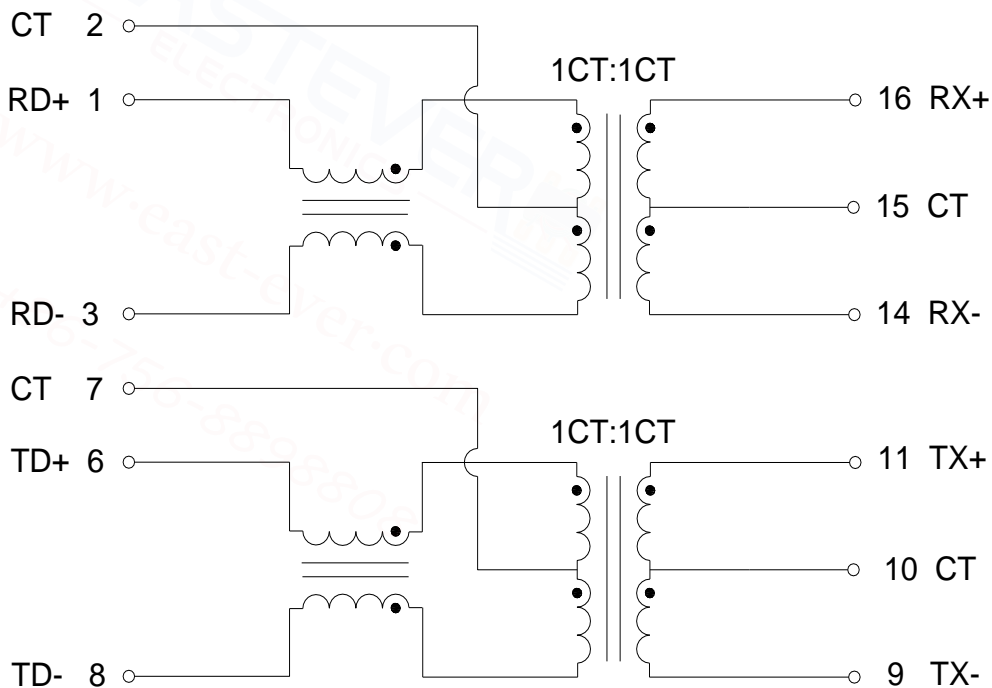

LAN Transformer

10/100 BASE-TX P16511G

REV: 0

C. ELECTRICAL SPECIFICATIONS @25°C

1. OCL: 350uH Min @ 100 KHz, 0.1V 8mA DC BIAS
2. Leakage Inductance: 0.5uH Max @ 100KHz, 0.1V
3. DCR: 1400mΩ Max
4. Turns Ratio: 1CT:1CT±5%
5. Insertion Loss: -1.1 dB Max @ 1-100 MHz
6. Return Loss: -18 dB Min @ 1-30 MHz
 - 14.4 dB Min @ 40 MHz
 - 13.1 dB Min @ 50 MHz
 - 12 dB Min @ 60-80 MHz
7. Cross Talk: -30 dB Min @ 1-100 MHz
8. Common Mode Rejection: -30 dB Min @ 1-100 MHz
9. Isolation Hipot: 1500VAC 1mA 60S
10. Operating temperature 0°C to +70°C
11. Storage temperature -25°C to +125°C

D. PACKAGE INFORMATION

Package Quantity:

One Tube=25Pcs

One Carton=25*320=8000Pcs

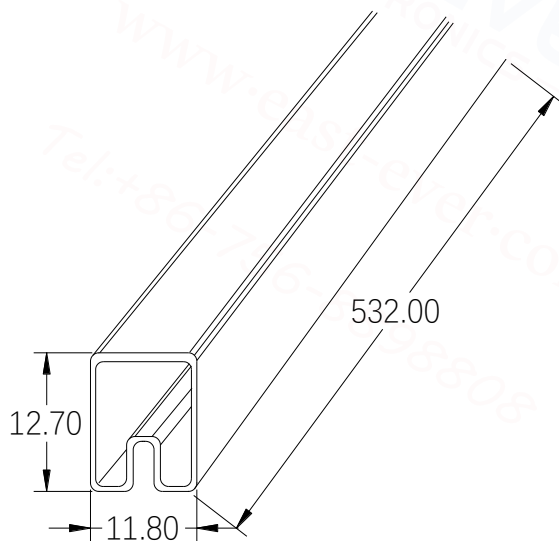

Tube:532.00*11.80*12.70mm

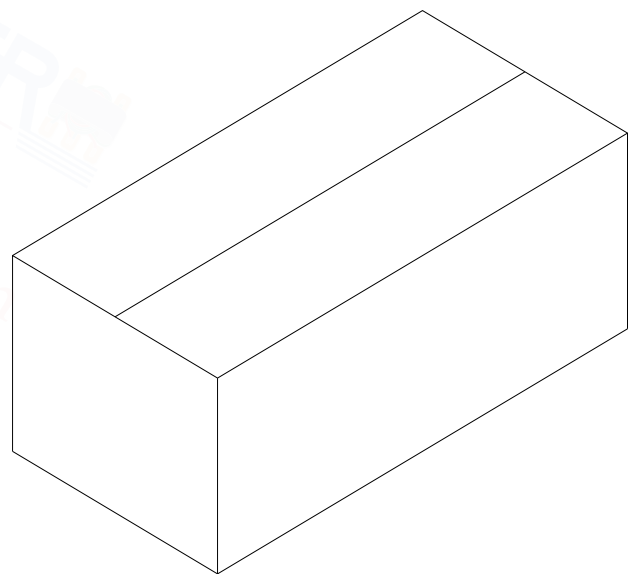

Carton: L550*W250*H210mm