

Features:

- ◆ Equivalent to: MABA-007731-CT1980
- ◆ 50Ω&75Ω Impedance
- ◆ Frequency: 50 to 2150 MHz
- ◆ RF power: 0.25W
- ◆ DC current: 30mA
- ◆ Insertion loss: 3.0dB Max; Input Return loss: 13.0dB Min
- ◆ Operating temperature range: -40°C to +85°C
- ◆ Storage temperature range: -55°C to +100°C



Applications:

- ◆ For broadband and wireless communications
- ◆ For VHF/UHF receivers/transmitters and push-pull amplifiers

Dimension Diagram (Unit:mm) :

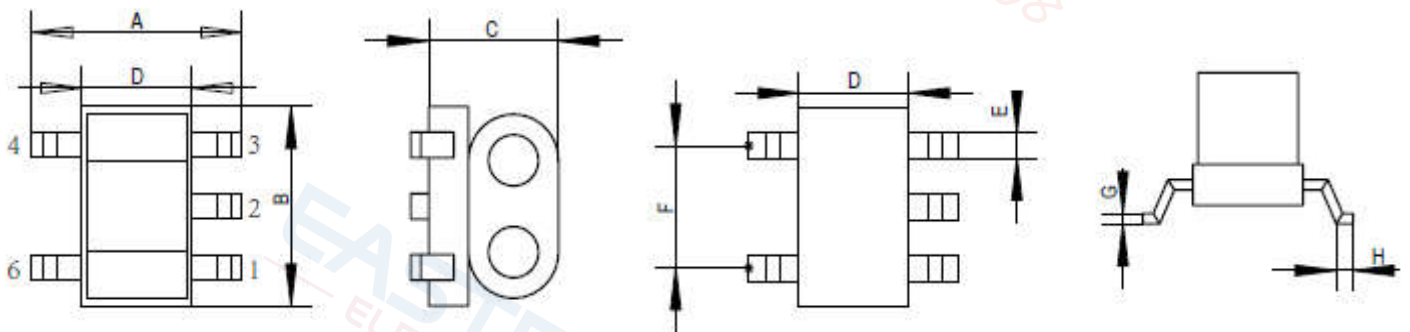

A=5.10±0.20 B=4.30±0.20 C=3.20±0.20 D=2.80±0.20 E=0.50±0.10 F=3.00±0.10 G=0.25±0.10 H=0.50±0.10

Electrical structure:

Recommended layout:

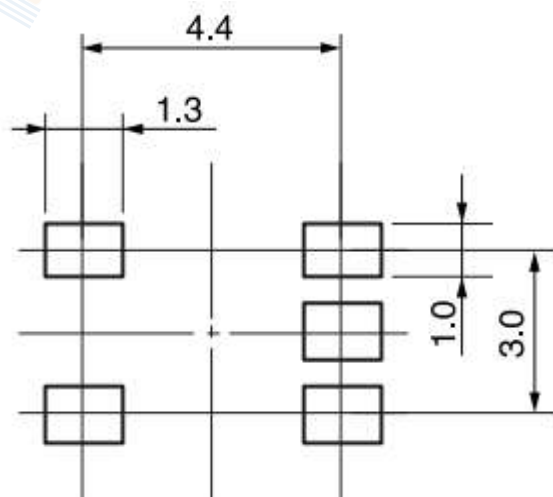
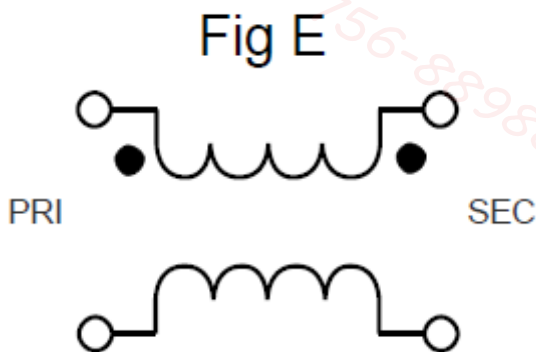

Pin configuration:

Pin No.	Function
1	Secondary dot (Output 1)
2	Not connected
3	Secondary (Output 2)
4	Primary (Ground)
6	Primary dot (Input)

Application circuit :

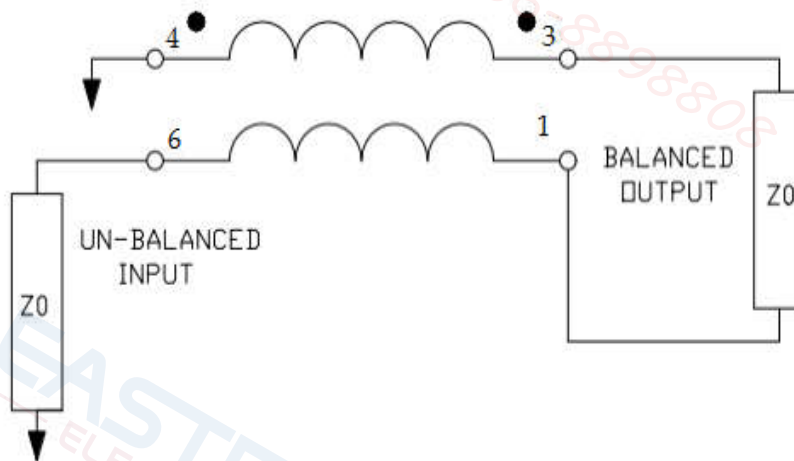

Electrical Specifications: TA=25°C, 0dBm, Z0=75Ω:

Parameter	Test Conditions	Units	Min	Typ	Max
Main line Loss(out1)	8-750MHz	dB	—	0.3	1.5
	750-2150MHz	dB	—	1.5	3.0
Main line Loss(out2)	8-750MHz	dB	—	0.8	1.5
	750-2150MHz	dB	—	1.0	3.0
Amplitude Balance	50-1250MHz	dB	—	±0.5	±2.0
Phase Balance	50-1250MHz	Degrees	—	±10	±10.0
Input Return Loss	50-1250MHz	dB	13.0	22.0	—

Main line Loss(out1)

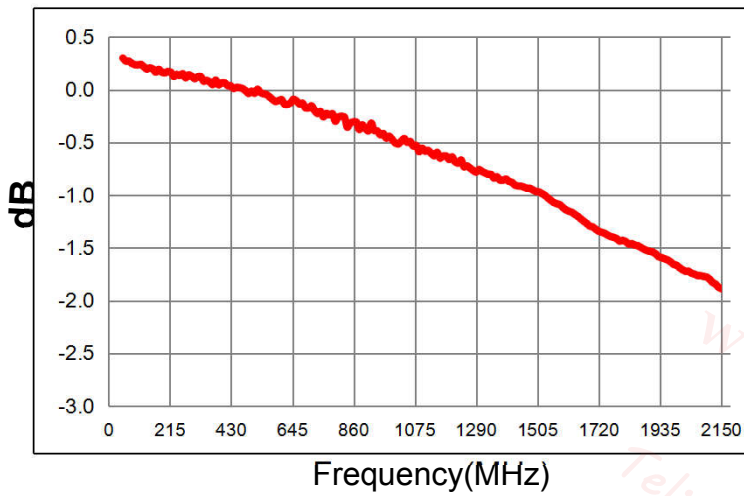

Main line Loss(out2)

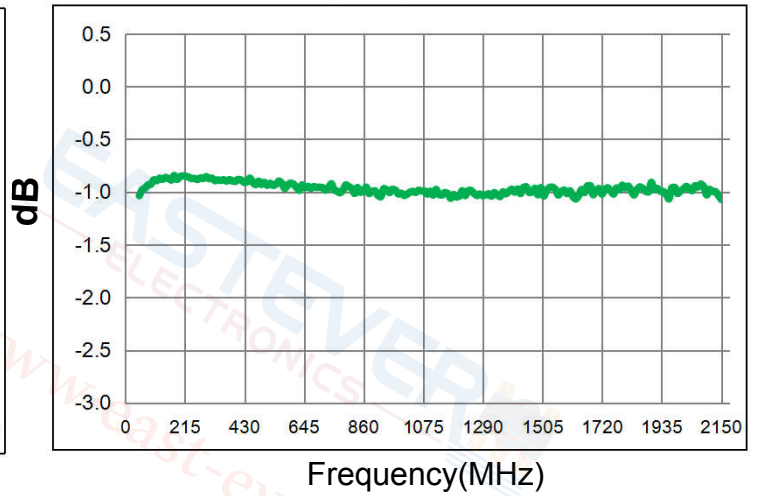

Amplitude Balance

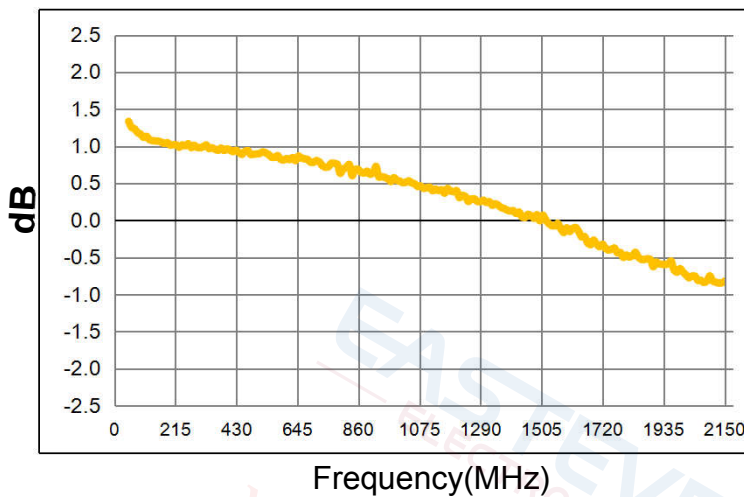

Phase Balance

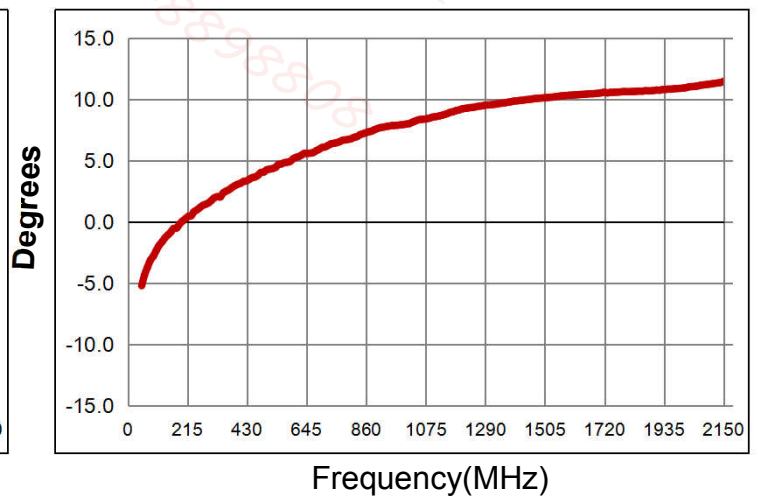

Input Return Loss

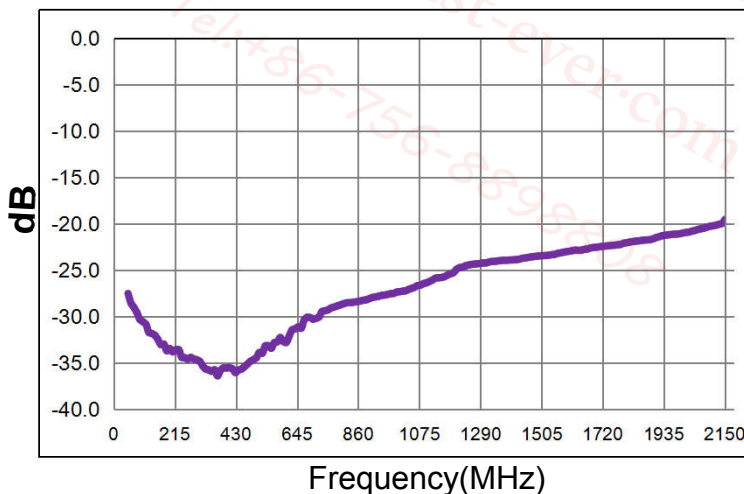

Recommended Soldering Temperature Graph:

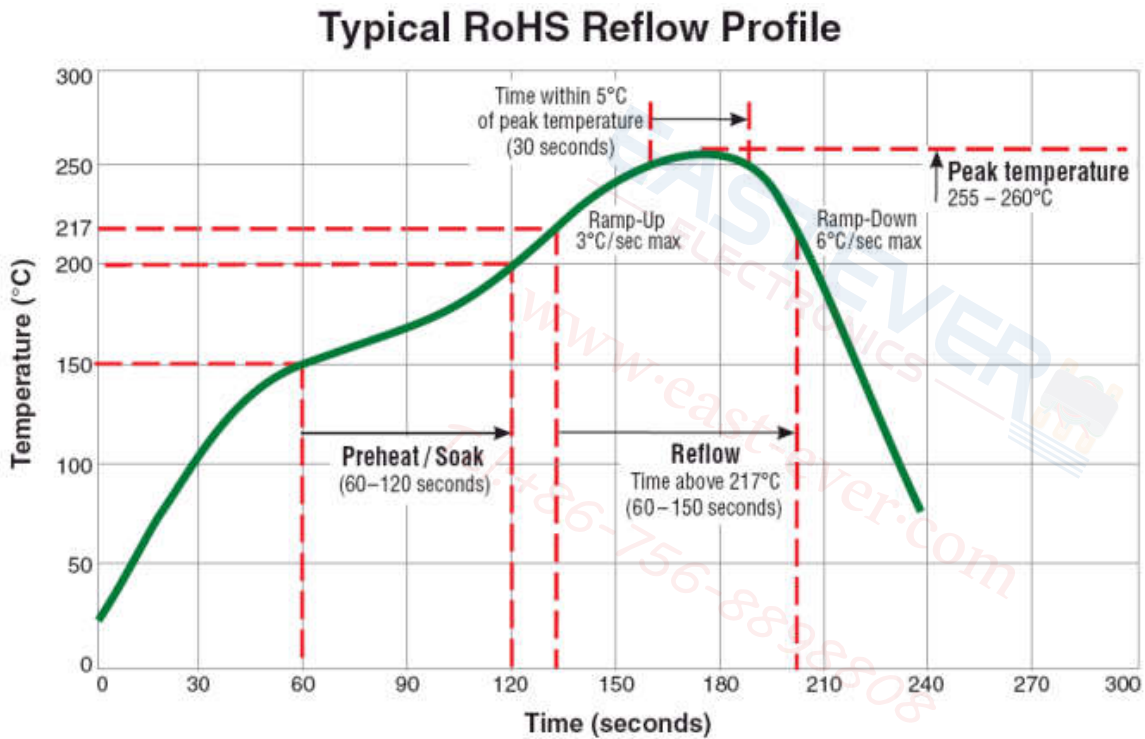

Packing Dimension For Caeier Tape(UNIT:mm):

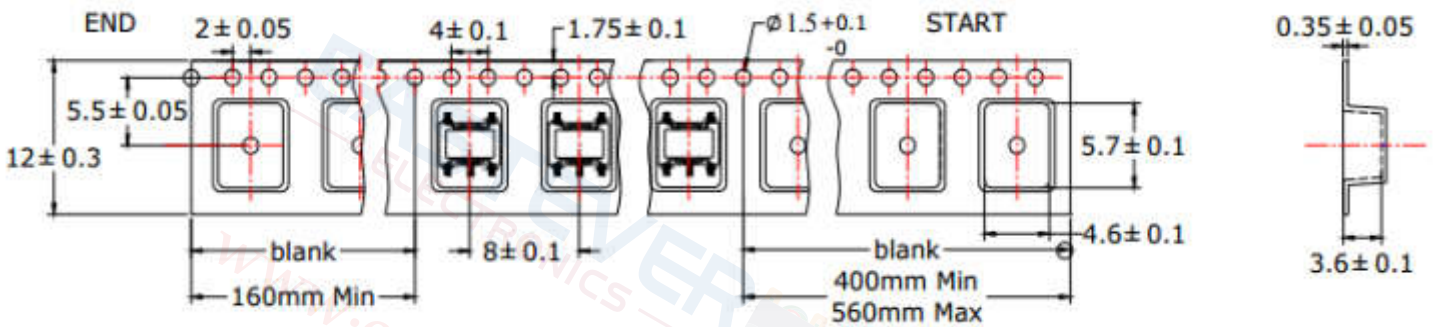

QUANTITY
2000pcs/reel
4Reel/Middle Carton
4Middle Carton/Big Carton
32000pcs/Big Carton



SPEC	8	12	16	24
DIM A±0.1	8.5	12.5	16.5	24.5
DIM B±0.1	2.3	2.3	2.3	2.3
DIM C±0.1	100	100	100	100

